

Invacare® TDX® SP2 Series



en Power Wheelchair User Manual

This manual **MUST** be given to the user of the product.
BEFORE using this product, this manual **MUST** be read and saved for
future reference.



Yes, you can.®

Contents

1 General	4
1.1 Introduction	4
1.2 Symbols in This Manual	4
1.3 Compliance	5
1.3.1 Product-Specific Standards	5
1.4 Usability	5
1.5 Warranty Information	6
1.6 Service Life	6
1.7 Limitation of Liability	6
2 Safety	7
2.1 General Safety Notes	7
2.2 Safety Information on the Electrical System	10
2.3 Safety Information on Electromagnetic Interference	11
2.4 Safety Information on Driving and Freewheel Mode	12
2.5 Safety Information With Regard to Care and Maintenance	14
2.6 Safety Information Regarding Changes and Modifications to the Power Wheelchair	15
2.7 Safety Information on Power Wheelchairs with a Lifter	16
3 Product Overview	18
3.1 Intended Use	18
3.1.1 Product Description	18
3.1.2 Intended User	18
3.1.3 Indications	18
3.2 Type Classification	18
3.3 Labels on Product	19
3.4 Main Parts of Wheelchair	22
3.5 User Inputs	23
3.6 The Lifter	23
4 Accessories / Options	24
4.1 Posture Belts	24
4.1.1 Types of Posture Belts	24
4.1.2 Adjusting Posture Belt Correctly	24
4.2 Adjusting or Removing Luggage Carrier	25
4.3 Using Cane Holder	25
5 Usage	26
5.1 General Setup Information	26
5.2 Driving	26
5.3 Before Driving for First Time	26
5.4 Parking and Stationary	26
5.5 Getting in and out of Power Wheelchair	26
5.5.1 Removing Standard Armrest for Side Transfer	26
5.5.2 Swivelling Remote to Side	27
5.5.3 Swivelling Nucleus Midline Holder to Side	29
5.5.4 Swivelling Swing-Away Display Holder to Side	29
5.5.5 Swivelling Chin Control to Side	30
5.5.6 Information About Getting in and out	30

© 2024 Invacare Corporation

All rights reserved. Republication, duplication or modification in whole or in part is prohibited without prior written permission from Invacare. Trademarks are identified by ™ and ®. All trademarks are owned by or licensed to Invacare Corporation or its subsidiaries unless otherwise noted.

5.6	Taking Obstacles	30	8.2.2	Weekly	51
5.6.1	Maximum Obstacle Height	31	8.2.3	Monthly	52
5.6.2	Safety Information When Taking Obstacles	31	8.3	Wheels and Tyres	53
5.6.3	Correct Way to Take Obstacles	31	8.4	Short-Term Storage	53
5.7	Driving up and down Gradients	32	8.5	Long-Term Storage	54
5.8	Use on Public Roads	33	8.6	Cleaning and Disinfection	54
5.9	Pushing Power Wheelchair in Freewheel Mode	33	8.6.1	General Safety Information	54
5.9.1	Disengaging Motors	33	8.6.2	Cleaning Intervals	55
6	Control System	35	8.6.3	Cleaning	55
6.1	Controls Protection System	35	8.6.4	Disinfection Instructions	56
6.2	Batteries	35	9	After Use	57
6.2.1	General Information on Charging	35	9.1	Reconditioning	57
6.2.2	General Instructions on Charging	35	9.2	Disposal	57
6.2.3	Charging Batteries	36	10	Technical Data	58
6.2.4	Disconnecting Power Wheelchair after Charging	37	10.1	Technical Specifications	58
6.2.5	Storage and Maintenance	37	11	Service	66
6.2.6	Instructions on Using Batteries	38	11.1	Inspections Performed	66
6.2.7	Transporting Batteries	38			
6.2.8	General Instructions on Handling Batteries	39			
6.2.9	Handling Damaged Batteries Correctly	39			
7	Transport	40			
7.1	Transport — General Information	40			
7.2	Transferring Power Wheelchair to Vehicle	40			
7.3	Use Power Wheelchair as Vehicle Seat	41			
7.3.1	How the Power Wheelchair is Anchored in a Vehicle	43			
7.3.2	Securing User in Power Wheelchair	44			
7.4	Transporting Power Wheelchair Without Occupant	46			
7.5	Dahl Docking System	46			
8	Maintenance	50			
8.1	Maintenance Introduction	50			
8.2	Inspection Checks	50			
8.2.1	Before Each Use of Power Wheelchair	51			

1 General

1.1 Introduction

This user manual contains important information about the handling of the product. To ensure safety when using the product, read the user manual carefully and follow the safety instructions.

Only use this product if you have read and understood this manual. Seek additional advice from a healthcare professional who is familiar with your medical condition and clarify any questions regarding the correct use and necessary adjustment with the healthcare professional.

Note that there may be sections in this document, which are not relevant to your product, since this document applies to all available models (on the date of printing). If not otherwise stated, each section in this document refers to all models of the product.

The models and configurations available in your country can be found in the country-specific sales documents.

Invacare reserves the right to alter product specifications without further notice.

Before reading this document, make sure you have the latest version. You find the latest version as a PDF on the Invacare website. Previous product versions may not be described in this Manual's current revision. If you require assistance, please contact Invacare.

If you find that the font size in the printed document is difficult to read, you can download the PDF version from the website. The PDF can then be scaled on screen to a font size that is more comfortable for you.

For more information about the product, for example product safety notices and product recalls, contact your Invacare distributor. See addresses at the end of this document.

In case of a serious incident with the product, you should inform the manufacturer and the competent authority in your country.

1.2 Symbols in This Manual

Symbols and signal words are used in this manual and apply to hazards or unsafe practices which could result in personal injury or property damage. See the information below for definitions of the signal words.



DANGER!

Indicates a hazardous situation that will result in serious injury or death if it is not avoided.



WARNING!

Indicates a hazardous situation that could result in serious injury or death if it is not avoided.



CAUTION!

Indicates a hazardous situation that could result in minor or slight injury if it is not avoided.



NOTICE!

Indicates a hazardous situation that could result in damage to property if it is not avoided.



Tips and Recommendations

Gives useful tips, recommendations, and information for efficient, trouble-free use.



Tools

Identifies required tools, components and items which are needed to carry out certain work.

Other Symbols

(Not applicable for all manuals)



UK Responsible Person

Indicates if a product is not manufactured in the UK.



Triman

Indicates recycling and sorting rules (only relevant for France).

1.3 Compliance

Quality is fundamental to the company's operation, working within the disciplines of ISO 13485.

This product features the CE mark, in compliance with the Medical Device Regulation 2017/745 Class I.

This product features the UKCA mark, in compliance with Part II UK MDR 2002 (as amended) Class I.

We are continuously working towards ensuring that the company's impact on the environment, locally and globally, is reduced to a minimum.

We only use REACH compliant materials and components.

We comply with the current environmental legislations WEEE and RoHS.

1.3.1 Product-Specific Standards

The product has been tested and conforms to EN 12184 (Electrically powered wheelchairs, scooters and their chargers) and all related standards.

When equipped with an appropriate lighting system, the product is suitable for use on public roads.

For further information about local standards and regulations, contact your local Invacare distributor. See addresses at the end of this document.

1.4 Usability

Only use a power wheelchair when it is in perfect working order. Otherwise, you might put yourself and others at risk.

The following list does not claim to be exhaustive. It is only intended to show some of the situations that could affect the usability of your power wheelchair.

In certain situations, you should immediately stop using your power wheelchair. Other situations allow you to use the power wheelchair to get to your provider.

You should immediately stop using your power wheelchair if its usability is restricted due to:

- Unexpected driving behaviour
- brake failure

You should immediately contact an authorised Invacare provider if the usability of your power wheelchair is restricted due to:

- the lighting system (if fitted) failing or being defective
- reflectors falling off
- worn thread or insufficient tire pressure
- damage to the armrests (e.g. torn armrest padding)
- damage to the legrest hangers (e.g. missing or torn heel straps)
- damage to the postural belt
- damage to the joystick (joystick cannot be moved into the neutral position)
- cables that are damaged, kinked, pinched or have come loose from the fixation
- the power wheelchair drifting when braking
- the power wheelchair pulling to one side when moving
- unusual sounds developing or occurring

Or if you have the feeling that something is wrong with your power wheelchair.

1.5 Warranty Information

We provide a manufacturer's warranty for the product in accordance with our General Terms and Conditions of Business in the respective countries.

Warranty claims can only be made through the provider from whom the product was obtained.

1.6 Service Life

We estimate a service life of five years for this product, provided it is used in strict accordance with the intended use as set out in this document and all maintenance and service requirements are met. The estimated service life can be exceeded if the product is carefully used and properly maintained, and provided technical and scientific advances do not result in technical limitations. The service life can also be considerably reduced by extreme or incorrect usage. The fact that we estimate a service life for this product does not constitute an additional warranty.

1.7 Limitation of Liability

Invacare accepts no liability for damage arising from:

- Non-compliance with the user manual
- Incorrect use
- Natural wear and tear
- Incorrect assembly or set-up by the purchaser or a third party
- Technical modifications
- Unauthorised modifications and/or use of unsuitable spare parts

2 Safety

2.1 General Safety Notes



WARNING!

Risk of Serious Injury or Damage

Improper use of this product may cause injury or damage.

- If you are unable to understand the warnings, cautions or instructions, contact a health care professional or provider before attempting to use this equipment.
- Do not use this product or any available optional equipment without first completely reading and understanding these instructions and any additional instructional material such as user manual, service manual or instruction sheet supplied with this product or optional equipment.



DANGER!

Risk of Death, Serious Injury, or Damage

Lighted cigarettes dropped onto an upholstered seating system can cause a fire resulting in death, serious injury, or damage. Power wheelchair occupants are at particular risk of death or serious injury from these fires and resulting fumes because they may not have the ability to move away from the power wheelchair.

- DO NOT smoke while using this power wheelchair.



WARNING!

Risk of Serious Injury or Damage

Storing or using the power wheelchair near open flame or combustible products can result in serious injury or damage.

- Avoid storing or using the power wheelchair near open flame or combustible products.



WARNING!

Risk of damage or injury if power wheelchair is accidentally set into motion

- Switch the power wheelchair off before you get in, get out or handle unwieldy objects.
- When the drive is disengaged, the brake inside the drive is deactivated. For this reason, pushing the power wheelchair by an attendant is only recommended on flat surfaces, never on gradients. Never leave your power wheelchair on a gradient with its motors disengaged. Always re-engage the motors immediately after pushing the power wheelchair (refer to *5.9 Pushing Power Wheelchair in Freewheel Mode*, page 33).



WARNING!

Risk of Injury, Damage or Death

Improper monitoring or maintenance may cause injury, damage or death due to ingestion or choking on parts or materials.

- Closely supervise children, pets, or people with physical / mental disabilities.



WARNING!

Risk of Death, Serious Injury or Damage

Risk of entrapment and strangulation when loose personal belongings (e.g. jewellery, scarfs) get caught by moving or protruding parts.

- Make sure that any loose items are clear of moving parts of the power wheelchair, e.g. wheels or powered seating components.
- Keep your hands, clothing and all other objects away from wheels or powered seating components when they are in operation.
- Power off power wheelchair immediately to stop any movement.



medication or alcohol. If necessary, the power wheelchair must be operated by an attendant who is physically and mentally able.



WARNING!

Risk of injury if the power wheelchair is switched off while driving, for example by pressing the On/Off Button or disconnecting a cable, due to it coming to an abrupt, sharp stop

- If you have to brake in an emergency, simply release the joystick which will bring you to a halt (refer to the remote user manual for more information).



WARNING!

Risk of Death, Serious Injury or Damage

Improper routing of cables may cause a tripping entanglement or strangulation hazard that may result in death, serious injury or damage.

- Ensure all cables are routed and secured properly.
- Ensure there are no loops of excess cable extending away from the wheelchair.



WARNING!

Risk of injury when transferring power wheelchair to a vehicle for transport with the occupant seated in it

- It is always better to transfer the power wheelchair to a vehicle without the occupant seated in it.
- If the power wheelchair needs to be loaded up a ramp together with its driver, ensure that the ramp does not exceed the rated slope (refer to *10.1 Technical Specifications, page 58*).
- If the power wheelchair does need to be loaded using a ramp which exceeds the rated slope (refer to *10.1 Technical Specifications, page 58*), then you must use a winch. An attendant can safely monitor and assist the loading process.



WARNING!

Risk of injury if the power wheelchair is driven when ability to operate a vehicle is impaired by medication or alcohol

- Never drive the power wheelchair under the influence of



- As an alternative you can use a platform lift. Ensure that the total weight of the power wheelchair including the user does not exceed the maximum permissible weight for the platform lift or winch if you are using.

**WARNING!****Risk of falling out of the power wheelchair**

- Do not slide forward on the seat, do not lean forward between your knees, do not lean backwards out over the top of the backrest, for example to reach an object.
- If a posture belt is installed, it should be correctly adjusted and used each time you use the power wheelchair.
- When transferring to a different seat, position the power wheelchair as close as possible to the new seat.

**CAUTION!****Risk of injury if maximum permissible load is exceeded**

- Do not exceed the maximum permissible load (refer to *10.1 Technical Specifications, page 58*).
- The power wheelchair is only designed for use by a single occupant whose maximum weight does not exceed the maximum permissible load of the device. Never use the power wheelchair to transport more than one person.

**CAUTION!****Risk of injury due to wrong lifting or dropping of heavy components**

- When maintaining, servicing or lifting any part of your power wheelchair, take into account the weight of the individual components especially the batteries. Be sure at all times to adopt the correct lifting posture and ask for assistance if necessary.

**CAUTION!****Risk of injury by moving parts**

- Make sure that no injury is incurred by moving parts of the power wheelchair, like wheels or one of the lifter modules (if fitted), especially when children are around.

**CAUTION!****Risk of injury from hot surfaces**

- Do not leave the power wheelchair in direct sunlight for prolonged periods. Metal parts and surfaces such as the seat and armrests can become very hot.

**CAUTION!****Risk of fire or breaking down due to electric devices being connected**

- Do not connect any electric devices to your power wheelchair that are not expressly certified by Invacare for this purpose. Have all electrical installations done by your authorised Invacare provider.

2.2 Safety Information on the Electrical System



WARNING!

Risk of death, serious injury or damage

Misuse of the power wheelchair may cause the power wheelchair to start smoking, sparking, or burning. Death, serious injury, or damage may occur due to fire.

- DO NOT use the power wheelchair other than its intended purpose.
- If the power wheelchair starts smoking, sparking, or burning, discontinue using the power wheelchair and seek service IMMEDIATELY.



WARNING!

Risk of death or serious injury

Electric shock can cause death or serious injury

- To avoid electric shock, inspect plug and cord for cuts and / or frayed wires. Replace cut cords or frayed wires immediately.



WARNING!

Risk of death or serious injury

Failure to observe these warnings can cause an electrical short resulting in death, serious injury, or damage to the electrical system.

- The POSITIVE (+) RED battery cable MUST connect to the POSITIVE (+) battery terminal(s) / post(s).



- The NEGATIVE (-) BLACK battery cable MUST connect to the NEGATIVE (-) battery terminal(s) / post(s).
- NEVER allow any of your tools and / or battery cable(s) to contact BOTH battery post(s) at the same time. An electrical short may occur and serious injury or damage may occur.
- Install protective caps on positive and negative battery terminals.
- Replace cable(s) immediately if cable(s) insulation becomes damaged.
- DO NOT remove fuse or mounting hardware from POSITIVE (+) red battery cable mounting screw.



WARNING!

Risk of death, serious injury, or damage

Corroded electrical components due to water or liquid exposure can result in death, serious injury, or damage.

- Minimize exposure of electrical components to water and / or liquids.
- Electrical components damaged by corrosion MUST be replaced immediately.
- Power wheelchairs that are frequently exposed to water / liquids may require replacement of electrical components more frequently.

**WARNING!****Risk of fire**

Switched on lamps produce heat. If you cover the lamps with fabrics such as clothes, there is a risk that the fabric may catch fire.

- NEVER cover the light system with fabric.

**WARNING!****Risk of death, serious injury or damage when carrying along oxygen systems**

Textiles and other materials that normally would not burn are easily ignited and burn with great intensity in oxygen enriched air.

- Check the oxygen tubing daily, from the cylinder to the delivery site, for leaks and hold away from electrical sparks and any source of ignition.

**WARNING!****Risk of injury or damage due to electrical shorts**

Connector pins on cables connected to the power module can still be live even when the system is off.

- Cables with live pins should be connected, restrained or covered (with non-conductive materials) so that they are not exposed to human contact or materials that could cause electrical shorts.



- When cables with live pins have to be disconnected, for example, when removing the bus cable from the remote for safety reasons, make sure to restrain or cover the pins (with non-conductive materials).

**NOTICE!**

A failure in the electric system can lead to unusual behavior such as continuous light, no light, or noises from the magnetic brakes.

- If a failure exists, switch off the remote and switch it on again.
- If a failure still exists, then disconnect or remove the power source. Depending on the power wheelchair model, you can either remove the battery packs or disconnect the batteries from the power module. If in doubt which cable to disconnect, contact your provider.
- In any case, contact your provider.

2.3 Safety Information on Electromagnetic Interference

This powered power wheelchair was successfully tested in accordance with International standards as to its compliance with Electromagnetic Interference (EMI) regulations. However, electromagnetic fields, such as those generated by radio and television transmitters, and cellular phones can influence the functions of powered power wheelchairs.

Also, the electronics used in our power wheelchairs can generate a low level of electromagnetic interference, which however will remain within the tolerance permitted by law. For these reasons we ask you to please observe the following precautions:



WARNING!

Risk of malfunction due to electromagnetic interference

- Do not switch on or operate portable transceivers or communication devices (such as radio transceivers or cellular phones) when the power wheelchair is switched on.
- Avoid getting near strong radio and television transmitters.
- In case the power wheelchair should be set in motion unintentionally or the brakes are released, switch it off immediately.
- Adding electrical accessories / options and other components or modifying the power wheelchair in any way can make it susceptible to electromagnetic interference. Keep in mind that there is no sure way to determine the effect such modifications will have on the overall immunity of the electronic system.
- Report all occurrences of unintentional movement of the power wheelchair, or release of the electric brakes to the manufacturer.



DANGER!

Risk of death, serious injury, or damage

- Malfunctioning joystick could cause unintended / erratic movement resulting in death, serious injury, or damage
- If unintended / erratic movement occurs, stop using the wheelchair immediately and contact a qualified technician.



WARNING!

Risk of serious injury or damage

- Improper positioning while leaning or bending could cause the wheelchair to tip forward resulting in serious injury or damage
- To assure stability and proper operation of your power wheelchair, you must at all times maintain proper balance. Your power wheelchair has been designed to remain upright and stable during normal daily activities as long as you DO NOT move beyond the centre of gravity.
 - DO NOT lean forward out of the power wheelchair any further than the length of the armrests.
 - DO NOT attempt to reach objects if you have to move forward in the seat or pick them up from the floor by reaching down between your knees.

**WARNING!****Risk of breaking down in adverse weather conditions, i.e. extreme cold, in an isolated area**

- If you are a user with severely limited mobility, we advise that in the case of adverse weather conditions DO NOT attempt a journey without an accompanying attendant.

**WARNING!****Risk of injury if the power wheelchair tips over**

- Inclines and declines can only be travelled up to the maximum safe slope (refer to *10.1 Technical Specifications, page 58*).
- Always return the backrest of your seat or the seat tilt to an upright position before ascending slopes. We recommend that you position the seat backrest and the seat tilt (if fitted) slightly to the rear before descending slopes.
- Only ever drive downhill at a maximum of 2/3 of the top speed.
- Avoid abrupt braking or accelerating on gradients.
- If at all possible, avoid driving on wet, slippery, icy, or oily surfaces (such as snow, gravel, ice etc.) where there is a risk of you losing control over the vehicle, especially on a gradient. This may include certain painted or otherwise treated wood surfaces. If driving on such a surface is inevitable, then always drive slowly and with the utmost caution.



- Never attempt to overcome an obstacle when on an uphill or downhill gradient.
- Never attempt to drive up or down a flight of steps with your power wheelchair.
- When overcoming obstacles, always observe the maximum obstacle height and information about overcoming obstacles (refer to *5.6 Taking Obstacles, page 30*).
- Avoid shifting your centre of gravity as well as abrupt joystick movements and changes of direction when the power wheelchair is in motion.
- Never use the power wheelchair to transport more than one person.
- Do not exceed the overall maximum permissible load or the maximum load per axle (refer to *10.1 Technical Specifications, page 58*).
- Note that the power wheelchair will brake or accelerate if you change the driving mode whilst the power wheelchair is in motion.

**WARNING!****Risk of injury if your foot slides off the footrest and gets caught underneath the power wheelchair when it is in motion**

- Make sure each time before you drive the power wheelchair that your feet are squarely and securely in place on the footplates, and that both legrests are properly locked into place.



WARNING!

Risk of injury if you collide with an obstacle when driving through narrow passages such as doorways and entrances

- Drive through narrow passages in the lowest driving mode and with due caution.



WARNING!

Risk of injury

If your power wheelchair has been fitted with elevating legrests, there is a risk of personal injury and damage to the power wheelchair if you drive the power wheelchair with the legrests raised.

- To avoid unwanted displacement of the power wheelchair centre of gravity to the front (especially when travelling downhill) and in order to avoid damage to the power wheelchair, elevating legrests must always be lowered during normal travelling.



WARNING!

Tipping hazard if antitippers are removed, damaged or changed to a position different to the factory settings

- Antitippers should only ever be removed for dismantling the power wheelchair for transport in a vehicle or for storage.
- The antitippers must always be fitted if the power wheelchair is being used.



WARNING!

Risk of tipping

Antitippers (stabilizers) are only effective on firm ground. They sink in on soft ground such as grass, snow or mud if the power wheelchair rests itself on them. They lose their effect and the power wheelchair can tip over.

- Only drive with extreme care on soft ground, especially during uphill and downhill journeys. In the process pay increased attention to the tip stability of the power wheelchair.

2.5 Safety Information With Regard to Care and Maintenance



WARNING!

Risk of death, serious injury, or damage

Incorrect repair and/or servicing of this power wheelchair performed by users/caregivers or unqualified technicians can result in death, serious injury, or damage.

- DO NOT attempt to carry out maintenance work that is not described in this user manual. Such repair and/or service MUST be performed by a qualified technician. Contact a provider or Invacare technician.

**CAUTION!****Risk of accident and loss of warranty if maintenance is insufficient**

- For reasons of safety and in order to avoid accidents which result from unnoticed wear, it is important that this power wheelchair undergoes an inspection once every year under normal operating conditions (see inspection plan contained in service instructions).
- Under difficult operating conditions such as daily travel on steep slopes, or in the case of use in medical care cases with frequently changing power wheelchair users, it would be expedient to carry out intermediate checks on the brakes, accessories / options and running gear.
- If the power wheelchair is to be operated on public roads, the vehicle driver is responsible for ensuring that it is in an operationally reliable condition. Inadequate or neglected care and maintenance of the power wheelchair will result in a limitation of the manufacturer's liability.

2.6 Safety Information Regarding Changes and Modifications to the Power Wheelchair

**CE marking of the power wheelchair:**

- The conformity assessment / CE marking was carried out according to the respective valid regulations and only applies to the complete product.

**WARNING!****Risk of serious injury or damage**

Use of incorrect or improper replacement (service) parts may cause injury or damage

- Replacement parts **MUST** match original Invacare parts.
- Always provide the wheelchair serial number to assist in ordering the correct replacement parts.

**CAUTION!****Risk of injuries and damage to power wheelchair due to unapproved components and accessories / options**

Seating systems, additions and accessories / options which have not been approved by Invacare for use with this power wheelchair can affect the tipping stability and increase tipping hazards.

- Only ever use seating systems, additions and accessories / options which have been approved by Invacare for this power wheelchair.
- Seating systems which are not approved by Invacare for use with this power wheelchair do not, under certain



circumstances, comply with the valid standards and could increase the flammability and the risk of skin irritation.

- Only use seating systems that have been approved by Invacare for this power wheelchair.



CAUTION!

Risk of injuries and damage to power wheelchair due to unapproved components and accessories / options

Electrical and electronic components which have not been approved by Invacare for use with this power wheelchair can cause fire hazards and lead to electromagnetic damage.

- Only ever use electrical and electronic components which have been approved by Invacare for this power wheelchair.

Batteries which have not been approved by Invacare for use with this power wheelchair can cause chemical burns.

- Only ever use batteries which have been approved by Invacare for this power wheelchair.



CAUTION!

Risk of injuries, and damage to the power wheelchair, if unapproved backrests are used

A retrofitted backrest which is not approved by Invacare for use with this power wheelchair may overload the backrest tube and thus increase the risk of injuries and of damage to the power wheelchair.



- Please contact your Invacare specialist provider who will perform risk analyses, calculations, stability checks etc. to ensure that the backrest can be used safely.



Important information about maintenance work tools

Some maintenance work which is described in this manual and can be carried out by the user without problems require the correct tools for proper work. If you do not have the correct tool available we do not recommend that you try to carry out the relevant work. In this case, we urgently recommend that you contact an authorised specialist workshop.

2.7 Safety Information on Power Wheelchairs with a Lifter



WARNING!

Risk of injury by moving parts

- Never let objects get caught in the space underneath a raised lifter.
- Make sure that neither you nor anyone else is injured by placing hands, feet or other body extremities under the raised seat.
- Should you not be able to view under the seat, for example, due to limited manoeuvrability, turn the wheelchair once on its own axle before you lower the seat. This will allow you to make sure that nobody is located in the danger zone.

**CAUTION!****Risk of malfunction of the lifter module**

- Inspect the lifter module at regular intervals to make sure there are no foreign objects or visible damage, and to make sure the electric plugs are firmly inserted into their sockets.



- Inspect the lifter module at least once a month to make sure the automatic speed reduction function, which reduces the speed of the power wheelchair when the lifter is raised, is working properly (refer to the seating manual). Notify your authorised provider immediately if it is not working properly.

**CAUTION!****Damage to power wheelchair caused by one-sided loading on lifter pillar**

- One-sided loading occurs if the seat is raised and / or tilted. Always return your seat backrest to the upright position and the seat tilting to the horizontal position before ascending slopes. Never subject the lifter pillar to continuous single-sided loading. The raising and tilting function of the seat only provides additional rest positions.

**Important information regarding speed reduction with raised lifter**

If the lifter has been raised above a certain point, the drive electronics considerably reduces the speed of the wheelchair. If speed reduction has been activated, drive mode can only be used to carry out minor movements of the power wheelchair and not for regular driving. To drive normally, lower the lifter until the speed reduction has been deactivated again, refer to chapter *Driving and Seating Limitations* in the seating manual for details.

**CAUTION!****Risk of injury if the power wheelchair tips over**

- Never exceed the maximum permissible load (refer to *10.1 Technical Specifications, page 58*).
- Avoid dangerous driving situations when the lifter is in a raised position, such as trying to overcome obstacles like curbs or driving up or down steep gradients.
- Never lean out of the seat when the lifter is raised.

3 Product Overview

3.1 Intended Use

3.1.1 Product Description

The TDX SP2 is a centre wheel drive power wheelchair that can be established with a multitude of configurations.

3.1.2 Intended User

This power wheelchair was designed for adults and adolescents whose ability to walk is impaired, but who are still in terms of their eyesight and physically and mentally able to operate an electric power wheelchair.

3.1.3 Indications

The use of this power wheelchair is recommended for the following indications:

- The inability or a greatly restricted ability to walk within the scope of the basic requirement to be able to move within one's own four walls.
- The need to leave the dwelling place in order to get some fresh air during a short walk or to reach those places generally to be found at close distance to the dwelling and where everyday business is carried out.

Provision of power wheelchairs for interior and exterior areas is advisable if the use of hand-operated wheelchairs is no longer possible on account of the disability, yet proper operation of an electromotive drive unit is still practicable.

Contraindications



There are no contraindications known.





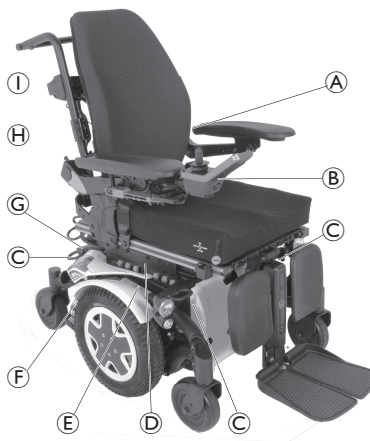





3.2 Type Classification

This vehicle has been classified according to EN 12184 as a **class B mobility product** (for indoor and outdoor areas). It is therefore compact and agile enough for indoor areas, but also able to overcome many obstacles in outdoor areas.

















3.3 Labels on Product













<p>Ⓐ</p>		<p>If the power wheelchair is fitted with a tray, it is imperative that it is removed and safely stowed when transporting the power wheelchair in a vehicle.</p> <p> The colour of the left and middle rectangles and cross bar is red. The colour of the right rectangle is green.</p>
<p>Ⓑ</p>		<p>Maximum speed label on the remote. The maximum speed is reduced to 3 km/h.</p> <p> The colour of the symbol background is red on product labels.</p>

C	 <p>ISO 7176-19</p>	<p>Identification of the tie-down points at the front and back: If the symbol appears on a bright yellow sticker, the anchoring point is suitable for fixation of the power wheelchair in a vehicle for use as a vehicle seat.</p>
D		<p>Warning regarding the use of the lifter. For details see below.</p> <p> The colour of the rectangles and diagonal bars is red on product labels.</p>
E		<p>Identification label sticker on the chassis at the right. For details see below.</p>
F		<p>Identification of the position of the coupling lever for driving and push operation (only the right side visible in the picture). For details see below.</p>
G	 <p>ISO 7176-19</p>	<p>Warning that the power wheelchair may not be used as a vehicle seat. This power wheelchair does not satisfy the requirements of ISO 7176-19.</p> <p> The colour of the symbol background is blue on product labels. The colour of the circle with diagonal bar is red on product labels.</p>
H		<p>Indication of pinch points that could occur on the power wheelchair.</p> <p> The colour of the symbol background is yellow on product labels.</p>
I		<p>Indication not to strain back with more than 6 kg.</p> <p> The colour of the symbol background is yellow on product labels.</p>

Explanation of Symbols on Labels

	Manufacturer		Unique Device Identification
	Date of manufacture		Battery type
	Medical device		Factory setting
	European Conformity		Serial number
	UK Conformity Assessed		Maximum speed
	QR code contains link to user manual		Rated slope
	Read the user manual		Unladen weight
	WEEE Conformity		Maximum user weight

	Do not lean out when the lifter is raised!		Do not drive up or down slopes when the lifter is raised!
	Do not allow any body parts to get under a raised seat!		Never drive with two people!
	Never drive over uneven surfaces when the lifter is raised!		
	<p>This symbol indicates the “Drive” position of the coupling lever. In this position the motor is engaged and the motor brakes are operational. You can drive the power wheelchair.</p> <ul style="list-style-type: none"> Note that for driving purposes both motors must always be engaged. 		

	<p>This symbol indicates the “Push” position of the coupling lever. In this position the motor is disengaged and the motor brakes are not operational. The power wheelchair can be pushed by an attendant and the wheels turn freely.</p> <ul style="list-style-type: none"> Note that the remote must be switched off. Also refer to 5.9 <i>Pushing Power Wheelchair in Freewheel Mode</i>, page 33.
	<p>This symbol indicates the OFF position of the circuit breaker switch. In this position the battery source is isolated and the power wheelchair cannot be operated or charged.</p>
	<p>This symbol indicates the ON position of the circuit breaker switch. In this position the battery source is connected and the power wheelchair can be operated or charged.</p>
	<p>This symbol indicates the circuit breaker.</p>
	<p>Read the user manual. This symbol appears on different labels and positions.</p>

3.4 Main Parts of Wheelchair



A Push handle

E Legrest

B Headrest (optional)

F Castor wheels

C Armrest

G Drive wheel

D Remote

H Engaging lever

3.5 User Inputs

Your power wheelchair may be fitted with one of several different user inputs. For information on the different functions and how to operate a particular user input, refer to its corresponding user manual (enclosed).

3.6 The Lifter

The electric lifter is operated from the remote. Refer to the remote manual for more information.



Information regarding operation of the lifter at temperatures of less than 0 °C

- Invacare power wheelchairs are fitted with safety mechanisms that prevent capacity overload of the electronic components. At operating temperatures below freezing point this can, in particular, lead to the lifter actuator being shut down after approx. 1 second operating time.
- The lifter can be raised or lowered gradually by repeatedly operating the joystick. In many cases this generates sufficient heat for the actuator to operate as normal.



Speed limiter

The speed limit reacts in different ways, depending on the power wheelchair's configuration.

- Either the lifter is fitted with sensors which reduce the power wheelchair's speed as soon as the lifter is raised above a certain point.
- Or if the speed limit is activated, a reduced drive level (forced profile) is set automatically. Refer to the remote manual for more information.
- The speed reduction takes place to guarantee the tipping stability of the power wheelchair and to avoid personal risk and damage to the power wheelchair.
- To reapply normal speed, lower the lifter down until the forced profile or the speed reduction switches off.
- If the power wheelchair is fitted with a chin control, it reacts different to forced profile. Refer to the manual of the chin control for more information.



CAUTION!

Risk of tipping, if the speed limiter sensors fail when the lifter is raised

- If you find that the speed reduction function is not working when the lifter is raised, do not drive with the lifter raised and immediately contact an authorised Invacare provider.

4 Accessories / Options

4.1 Posture Belts

A posture belt is an option which can either be fixed to the power wheelchair ex-works or can be retrofitted by your specialist provider. If your power wheelchair is fitted with a posture belt, your specialist provider will have informed you about fitting and usage.

The posture belt is used to help the power wheelchair user keep an optimum seating position. Correct use of the belt assists the user in sitting securely, comfortably and well-positioned in the power wheelchair, especially for such users who do not have such a good sense of balance while sitting.

 We recommend using the posture belt whenever the power wheelchair is used.

4.1.1 Types of Posture Belts

Your power wheelchair can be fitted with the following posture belt types ex-works. If your power wheelchair has been fitted with a different belt to those listed below, please ensure that you have received the manufacturer's documentation with regard to correct fitting and use.

Belt with Metal Buckle, Adjustable Both Sides



Belt can be adjusted on both sides. This means that the buckle can be centrally positioned.

Belt with Plastic Buckle, Adjustable Both Sides



Belt can be adjusted on both sides. This means that the buckle can be centrally positioned.

Harness with Metal Buckle, Adjustable Both Sides

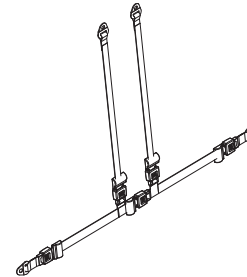

Harness can be adjusted on both sides. This ensures that the buckle is always centrally positioned.

4.1.2 Adjusting Posture Belt Correctly

 The belt should be tight enough to ensure that you are sitting comfortably and that your body is in the correct sitting position.

1. Ensure that you are sitting correctly, which means that you are sitting right at back of seat, your pelvis is positioned erect and as symmetrically as possible, not to front, to side or at one edge of seat.

2. Position posture belt so that your hipbones can be easily felt above belt.
3. Adjust belt length using one of adjustment aids described above. The belt should be adjusted so that you can fit a flat hand between belt and your body.
4. Buckle should be positioned as centrally as possible. In doing so, carry out adjustments on both sides as much as possible.
5. Check your belt every week to ensure that it is still in good working condition, to ensure it has no damage or wear, and that it is fixed properly to power wheelchair. If belt is only fastened with a bolted connection, ensure that connection has not loosened or come undone. You can find more information about maintenance work on belts in the service manual, which is available through Invacare.

4.2 Adjusting or Removing Luggage Carrier

- ! Risk of damage as a result of collisions**
Parts of the mobility device may be damaged if the luggage carrier collides with the seat during seat angle or backrest adjustment.
- Ensure that the luggage carrier is out of the range of both seat angle and backrest adjustment.

- ! Risk of breakage due to excessive load**
The luggage carrier can break if too great a load is applied.
- The maximum permitted load on the luggage carrier is 10 kg.

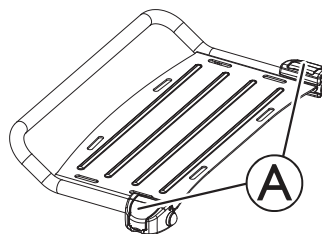

1. Open the clamp levers **A** of the luggage carrier bracket.
2. Slide the luggage carrier forward or backward or remove it.
3. Close the clamp levers of the luggage carrier bracket.

4.3 Using Cane Holder

If your power wheelchair is fitted with a cane holder, it can be used for the safe transport of a walking cane, underarm or forearm crutches. The cane holder consists of a plastic container (bottom) and a hook-and-loop fastener (top).



CAUTION! **Risk of Injury**

A walking cane or crutches that are not secured during transport (on the user's lap, for example) can cause injury to the user or other persons.

- During transport, walking canes or crutches should always be secured using a cane holder.

1. Open upper hook-and-loop fastener.
2. Place lower end of the walking cane or crutches in container at bottom.
3. Walking cane or crutches can be secured at upper end using hook-and-loop fastener.

5 Usage

5.1 General Setup Information

For more information about setup, see the user manual of the seating system.

5.2 Driving



The maximum load capacity that is stated in the technical data only states that the system is designed for this mass in total. However, this does not mean that one can sit a person with this body weight in the power wheelchair without restrictions. Attention must be paid to the body proportions, such as height, weight distribution, abdominal belt, leg and calf strap and seat depth. These factors have a strong influence on driving features such as tilt stability and traction. The permissible axle loads in particular must be adhered to (refer to *10.1 Technical Specifications, page 58*). It may possibly be necessary to carry out adaptations to the seat system.

5.3 Before Driving for First Time

Before you take your first trip, you should familiarise yourself well with the operation of the power wheelchair and with all operating elements. Take your time to test all functions and driving modes.



If installed, make sure to properly adjust and use the posture belt each time you use the power wheelchair.

Sitting comfortably = Driving safely

Before each trip, make sure that:

- You are within easy reach of all operating controls.
- The battery charge is sufficient for the distance you intend to travel.
- The posture belt (if installed) is in perfect order.
- The rear mirror (if installed) is adjusted so you can look behind at all times without having to bend forward or shift your seating position.

5.4 Parking and Stationary

When parking your power wheelchair or if your power wheelchair is stationary for a prolonged period:

1. Switch the power wheelchair's power system off (ON-/OFF key).

5.5 Getting in and out of Power Wheelchair



NOTICE!

- The armrest must be removed or swiveled up in order to get into or out of the power wheelchair from the side.

5.5.1 Removing Standard Armrest for Side Transfer



This chapter relates to the standard armrest. For more information about other armrests, see the user manual of the seating system.

Depending on version, the armrest is fixed with one of several fastener options:

- Clamping lever
- Hand screw
- Locking pin
- Locking screw

Depending on which side the remote is installed on, you need to disconnect the remote cable before removing the armrest.

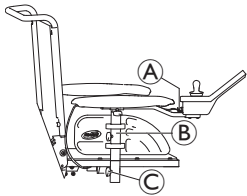

The graphic serves as example.

1. Pull plug **A** of remote cable to disconnect remote.
2. If necessary, remove remote cable from clip **B**.
3. Loosen fastener **C**.
4. Remove armrest from holder.

5.5.2 Swivelling Remote to Side

If your power wheelchair is fitted with a swivelling remote holder, then the remote can be moved away to the side, for example, to drive up close to a table.

Swing-Away Remote Holder

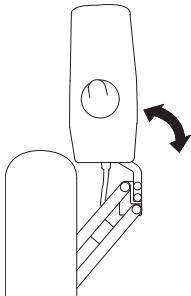

1. Push remote to swivel remote holder to the side.

Maxx Resolve Swing-Away Remote Holder



CAUTION!

Risk of Injury or Damage

Driving the power wheelchair and / or operating the power positioning functions with the remote in the swing-away position may cause collisions or unintended movement.

- Always pay close attention to surroundings when operating the power wheelchair to avoid collisions, damage or unintended movement.
- Always ensure there is sufficient clearance between the armrest pad and the joystick when the remote is in the swing-away position.



NOTICE!

Applying excessive tension to the front of the remote when operating the swing-away mechanism may cause damage to the internal belt-drive.

- Gentle tension should be applied to the middle of the remote which is closer to the pivot point of the swing-away mechanism. The tension to operate the swing-away mechanism can be set to fit the user's needs, refer to the seating manual.

! NOTICE!

Using the joystick to operate the swing away mechanism causes damage to the joystick.

- Do not use the joystick to operate the swing-away mechanism.

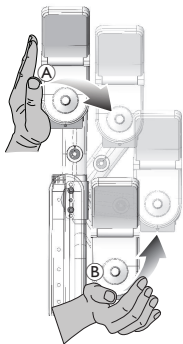

1. Push middle of remote (A) to operate swing-away mechanism.
2. Push forward and inward (B), until remote locks into home position with a click.

Quad Link Remote Holder**WARNING!****Risk of Pinch Points**

- Make sure fingers are not between the linkage bars when locking the Quad Link retractable remote mount into position. Pinch points will occur between the linkage bars when locking the Quad Link into position.

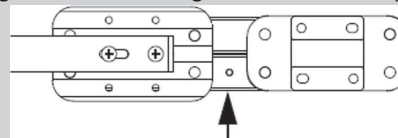
**Swivel Remote to Side**

- 1.



To retract remote from normal extended position, push outward on inside surface of remote until Quad Link is free.



The Quad Link works the best when the remote is pushed outward on the inside surface of the remote, near the armrest pad.

2. Push remote outward and rearward until Quad Link moves through its complete range into its fully retracted position.

Return Remote to Extended Position

1.

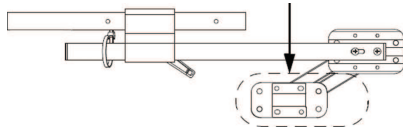

To return remote to normal extended position, push outward on inside surface of remote, then forward and inward until Quad Link moves through its complete range and clicks into its fully extended position.

5.5.3 Swivelling Nucleus Midline Holder to Side

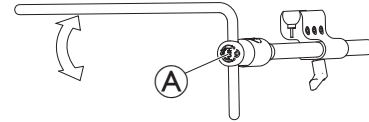

1. Push button (A) and swivel up or down nucleus.

5.5.4 Swivelling Swing-Away Display Holder to Side



The swing-away display holder only locks in place when swivelled to its default position.

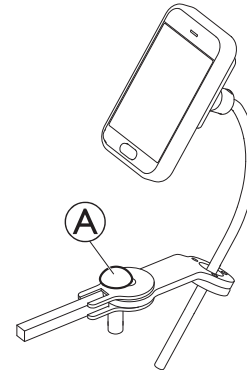

1. Push knob (A) and swivel display holder to side.

5.5.5 Swivelling Chin Control to Side

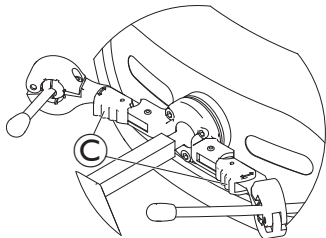

1. Press locking device © (behind headrest) and swivel joystick or egg switch inwards or outwards until it clicks in place.

5.5.6 Information About Getting in and out



WARNING!

Risk of serious injury or damage

Improper transfer techniques may cause serious injury or damage

- Before attempting transfers, consult a healthcare professional to determine proper transfer techniques for the user and type of wheelchair.
- Follow the instructions below.



If you do not have sufficient muscle strength, you should ask other persons for help. Use a sliding board, if possible.

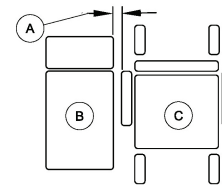
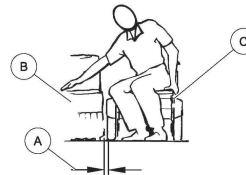

1. Reduce the gap between transfer surface ② and power wheelchair seat ③ to the minimum distance ① necessary to perform transfer. This might have to be done by an attendant.
2. Align castors parallel to drive wheels to improve stability during transfer.
3. Always switch your power wheelchair off.
4. Always engage both motor locks / clutches and free wheel hubs (if fitted) to prevent wheels from moving.
5. Depending on armrest type of your power wheelchair, detach armrest or swivel it up.
6. Now slide in or out of your power wheelchair.

5.6 Taking Obstacles

This power wheelchair is fitted with "SureStep" technology. When climbing over obstacles, the castors retract and raise. They extend and lower when descending.

5.6.1 Maximum Obstacle Height

The maximum obstacle height is:

- Forward: 75 mm
- Reverse: 50 mm

For more information, refer to *10.1 Technical Specifications, page 58*.

5.6.2 Safety Information When Taking Obstacles



CAUTION!

Risk of tipping over

- Never approach obstacles at an angle but at 90 degrees as shown below.
- Approach obstacles followed by a gradient with caution. If unsure whether the gradient is too steep or not, move away from the obstacle and if possible try to find another location.
- Never approach obstacles on an uneven and / or loose ground.
- Never drive with too low tire pressure.
- Put your backrest into an upright position before ascending an obstacle.



CAUTION!

Risk of falling out of the power wheelchair and damage to the power wheelchair such as broken castors

- Never approach obstacles that are higher than the maximum climbable obstacle height.
- Never let the footrest / legrest touch the ground when descending an obstacle.
- If unsure whether taking an obstacle is possible or not, move away from the obstacle and if possible find another location.

5.6.3 Correct Way to Take Obstacles



The following instructions how to take obstacles also apply for attendants if the power wheelchair is fitted with an attendant control.

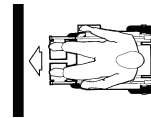

Ascending

1. Approach obstacle or curb slowly, head-on and at a right angle.
2. Stop in the following position:
approx. 5 - 10 cm in front of obstacle.
3. Check position of front wheels. They must be in driving direction and at right angles to obstacle.
4. Approach slowly and keep at consistent speed until rear wheels have also passed over obstacle.

Ascending Obstacles with Curb Climber

1. Approach obstacle or curb slowly, head-on and at a right angle.
2. Stop in the following position:
approx. 30 - 50 cm in front of obstacle.
3. Check position of front wheels. They must be in driving direction and at right angles to obstacle.
4. Approach full speed until curb climber makes contact with obstacle. Impetus will lift both front wheels over obstacle.
5. Keep at consistent speed until rear wheels have also passed over obstacle.

Descending

The approach to descend an obstacle is the same as to ascend it with the difference that you need not to stop before descending.

1. Descend obstacle with medium speed.



When descending an obstacle too slowly it could happen that the antitippers get stuck and lift the drive wheels off the ground. Driving the power wheelchair is then no longer possible.

5.7 Driving up and down Gradients

For information concerning the maximum safe slope, refer to *10.1 Technical Specifications, page 58*.



CAUTION!

Risk of tipping over

- Only ever drive downhill at a maximum of 2/3 of the top speed. Avoid sudden changes of direction or abrupt braking when driving on slopes.
- Always return the backrest of your seat or the seat tilt (if adjustable seat tilt is available) to an upright position before ascending slopes. We recommend that you position the seat backrest or the seat tilt slightly to the rear before descending slopes.
- Always lower the lifter (if fitted) to its lowest position before ascending or descending a slope.
- Never attempt to ascend or descend a slope on slippery surfaces or where there is a risk of skidding (such as wet pavement, ice etc).
- Avoid trying to get out of the power wheelchair on an incline or a gradient.
- Always drive straight in the direction the road or path you are on goes, rather than attempting to zigzag.
- Never attempt to turn around on an incline or a slope.

**CAUTION!**

Braking distance is much longer on a downhill slope than on even terrain

- Never drive down a slope that exceeds the rated slope (refer to *10.1 Technical Specifications, page 58*).

5.8 Use on Public Roads

If you wish to use your power wheelchair on public roads and lighting is required by national legislation, then your power wheelchair needs to be fitted with an appropriate lighting system. Additional modifications may be required depending on the country.

Contact your Invacare provider if you have any questions.

5.9 Pushing Power Wheelchair in Freewheel Mode

The motors of the power wheelchair are equipped with automatic brakes, preventing that the power wheelchair starts rolling out of control when the remote is switched off. When pushing the power wheelchair manually whilst freewheeling, the magnetic brakes must be disengaged.



Pushing the power wheelchair by hand may require more physical force than expected (more than 100 N). The necessary force nevertheless complies with the requirements of ISO 7176-14.



The intended use of the freewheel mode is to maneuver the power wheelchair over short distances. The push handles or push bars support this function, but be aware that there might be some impairment between the feet of the assistant and the rear part of the power wheelchair.

5.9.1 Disengaging Motors

**CAUTION!**

Risk of the power wheelchair running away

- When the motors are disengaged (for push operation whilst freewheeling), the electromagnetic motor brakes are deactivated. When the power wheelchair is parked, the engaging turn knobs of the motors must without fail be locked firmly into the "DRIVE" position (electromagnetic motor brakes activated).



The motors may only be disengaged by an attendant, not by the user.

This ensures that the motors are only disengaged if an attendant is available to secure the power wheelchair and prevent unintended rolling.

The engaging turn knob for disengaging the motors is located behind the motors.

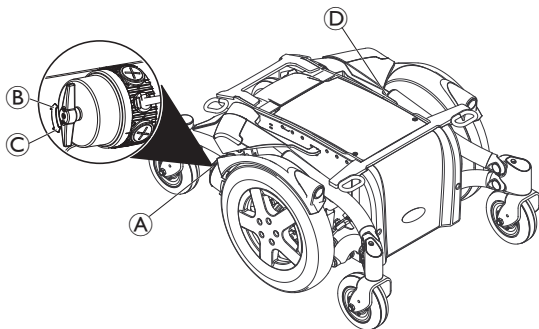

Disengaging Right Motor (from View of User)

1. Switch off remote.
2. Turn engaging turn knob of right motor **A** clockwise **B**.
Motor is disengaged.
3. Turn engaging turn knob of right motor **A** counterclockwise **C**.
Motor is engaged.

Disengaging Left Motor (from View of User)

1. Switch off remote.
2. Turn engaging turn knob of left motor **D** counterclockwise **C**.
Motor is disengaged.
3. Turn engaging turn knob of left motor **D** clockwise **B**.
Motor is engaged.

6 Control System

6.1 Controls Protection System

The wheelchair controls system is fitted with an overload protection.

If the drive is severely overloaded over a long period of time (for example, when driving up a steep hill) and especially when the ambient temperature is high, the controls system could overheat. In this case, the wheelchair performance is gradually reduced until it comes to a halt. The status display shows a corresponding error code (refer to the user manual for your remote). By switching the power supply off and back on again, the error code is cleared and the controls system is switched back on. It can however take up to five minutes until the controls system has cooled down enough for the drive to restore full performance again.

If the drive is stalled by an insurmountable obstacle, for example, a curb or similar which is too high, and the driver attempts driving for more than 20 seconds against this obstacle, the controls system automatically switches off to prevent the motors from being damaged. The status display shows a corresponding error code (refer to the user manual of your remote). By switching off and back on again, the error code is cleared and the controls system is switched back on.



A defective main fuse may be replaced only after checking the entire controls system. A specialised Invacare provider must perform the replacement. You can find information on the fuse type in *10.1 Technical Specifications, page 58*.

6.2 Batteries

Power is supplied by two 12 V batteries. The batteries are maintenance-free and only need regular charging.

In the following, you find information on how to charge, handle, transport, store, maintain, and use batteries.

6.2.1 General Information on Charging

New batteries should always be fully charged once before their first use. New batteries will be at their full capacity after having run through approx. 10 - 20 charging cycles (break-in period). This break-in period is necessary to fully activate the battery for maximum performance and longevity. Thus, range and running time of your power wheelchair could initially increase with use.

Gel/AGM lead acid batteries do not have a memory effect as NiCd batteries.

6.2.2 General Instructions on Charging

Follow the instructions listed below to ensure safe use and longevity of the batteries:

- Charge 18 hours prior to initial usage.
- We recommend charging the batteries daily after every discharge even after partly discharge, as well as each night over night. Depending on the level of discharge, it can take up to 12 hours until the batteries are fully charged again.
- When the battery indicator reached the red LED range, charge the batteries for 16 hours minimum, neglecting the charge complete display!

- Try to provide a 24 hour charge once a week to make sure that both batteries are fully charged.
- Do not cycle your batteries at a low state of charge without regularly recharging them fully.
- Do not charge your batteries under extreme temperatures. High temperatures above 30 °C are not recommended for charging as well as low temperatures below 10 °C.
- Use only charging devices in Class 2. This class of chargers may be left unattended during charging. All charging devices which are supplied by Invacare comply with these requirements.
- You cannot overcharge the batteries when using the charger supplied with your power wheelchair, or a charger that has been approved by Invacare.
- Protect your charger from sources of heat such as heaters and direct sunlight. If the battery charger overheats, charging current will be reduced and the charging process delayed.

6.2.3 Charging Batteries

Refer to the user manuals for your remote and battery charger for the position of the charging socket and further information about charging the batteries.



WARNING!

Risk of injury if using the power wheelchair during charging

- DO NOT attempt to recharge the batteries and operate the power wheelchair at the same time.
- DO NOT sit in the power wheelchair while charging the batteries.



WARNING!

Risk of fire

- Only charge the power wheelchair in a well-ventilated environment to prevent the accumulation of flammable gas.
- During the charging process explosive gases occur. Keep the power wheelchair and the charger away from sources of ignition such as flames and sparks.



WARNING!

Risk of explosion and destruction of batteries if the wrong battery charger is used

- Only ever use the battery charger supplied with your power wheelchair, or a charger that has been approved by Invacare.



WARNING!

Risk of electric shock and damage to the battery charger if it gets wet

- Protect the battery charger from water.
- Always charge in a dry environment.



WARNING!

Risk of short circuit and electric shock if the battery charger has been damaged

- Do not use the battery charger if it has been dropped or damaged.

**WARNING!****Risk of electric shock and damage to the batteries**

- NEVER attempt to recharge the batteries by attaching cables directly to the battery terminals.

**WARNING!****Risk of fire and electric shock if a damaged extension cable is used**

- Only ever use an extension cable if it is absolutely necessary. In case you must use one, make sure it is in good condition.

1. Switch off power wheelchair.
2. Connect battery charger to charger socket.
3. Connect battery charger to power supply.



The batteries are equipped with safety vents that allow for the evaporation of gas which is generated during the charging process. If the safety vents cannot release the gas properly, the batteries may overheat and permanently deform. An unpleasant smell and reduced function of the batteries may be noticed. However, the batteries remain safe. Stop charging immediately and let the power wheelchair cool down. Please contact your provider to exchange the batteries.

6.2.4 Disconnecting Power Wheelchair after Charging

1. Once charging is complete, first disconnect battery charger from power supply, then disconnect plug from remote.

6.2.5 Storage and Maintenance

Follow the instructions listed below to ensure safe use and longevity of the batteries:

- Always store the power wheelchair fully charged.
- Do not leave the batteries in a low state of charge for an extended length of time. Charge a discharged battery as soon as possible.
- In case your power wheelchair is not used for a longer period of time (that is more than two weeks), the batteries must be charged at least once a month to maintain a full charge and always be charged before use.
- Avoid hot and cold extremes when storing. We recommend to store power wheelchair at a temperature of 15 °C.
- Gel and AGM batteries are maintenance-free. Any performance issues should be handled by a properly trained power wheelchair technician.

6.2.6 Instructions on Using Batteries



CAUTION!

Risk of damaging the batteries.

- Avoid ultra-deep discharges and never drain your batteries completely.

- Pay attention to the Battery Charge Indicator! Charge the batteries when the Battery Charge Indicator shows that battery charge is low. How fast the batteries discharge depends on many circumstances, such as ambient temperature, condition of the surface of the road, tire pressure, weight of the driver, way of driving and utilisation of lighting, if fitted.
- Always try to charge the batteries, before the indicator on the remote is displaying the state of charge with red colour. The red colour means a remaining capacity about 20 %.
- When the red LED is flashing, the Battery Safe feature is enabled. From this time, speed and acceleration is reduced drastically. It will allow you to move the power wheelchair slowly out of a dangerous situation before the electronic finally cuts off. This is deep discharging and should be avoided.
- Driving with flashing red LED means an extreme stress for the battery and should be avoided under normal circumstances.
- Be aware that for temperatures below 20 °C, the nominal battery capacity starts to decline. For example, at -10 °C the capacity is reduced to about 50 % of the nominal battery capacity.

- To avoid damaging the batteries, never allow them to be fully discharged. Do not drive on heavily discharged batteries if it is not absolutely necessary, as this will strain the batteries unduly and shorten their life expectancy.
- The earlier you recharge the batteries, the longer they live.
- The depth of discharge affects the cycle life. The harder a battery has to work, the shorter is its life expectancy. Examples:
 - One deep discharge stresses the same as 6 normal cycles (green / orange display off).
 -  The battery indicator or number of LED can vary depending on the remote type.

The battery life is about 500 cycles at 80 % discharge (first 4 LED off / battery bar displays red), or about 5000 cycles at 10 % discharge (one LED off / battery bar displays green).
- Under normal operation, once a month the battery should be discharged until all green and orange LED are off or until battery bar displays red. This should be done within one day. A 16 hour charge afterwards is necessary as reconditioning.

6.2.7 Transporting Batteries

The batteries supplied with your power wheelchair are not hazardous goods. This classification is based on the German GGVS Hazardous Goods Road Transport Ordinances, and the IATA/DGR Hazardous Goods Rail Transport / Air Transport Ordinances. Batteries may be transported without restrictions, whether by road, rail or by air. Individual transport companies have, however, guidelines which can possibly restrict or forbid certain transport procedures. Please ask the transport company regarding each individual case.

6.2.8 General Instructions on Handling Batteries

- The batteries reach their end of life when the drive range is significantly smaller than usual. Contact your provider or service technician for details.
- Always have your batteries installed by a properly trained power wheelchair technician or a person with adequate knowledge. They have the necessary training and tools to do the job safely and correctly.

6.2.9 Handling Damaged Batteries Correctly

If the batteries are defective or damaged, the power wheelchair must not be used under any circumstances. Contact your provider regarding a repair or exchanging the batteries.

Damaged batteries shall only be handles by a properly trained power wheelchair technician.



WARNING! **Risk of burns**

- Never touch or remove overheating batteries. Only unplug the charger.
- Never touch leaking batteries.



CAUTION!

Corrosion and burns from acid leakage if batteries are damaged

- Remove clothes that have been soiled by acid immediately.

After contact with skin:

- Immediately wash affected area with lots of water.

After contact with eyes:

- Immediately rinse eyes under running water for several minutes; consult a physician.

Disposing of Dead or Damaged Batteries Correctly

Batteries are following special disposal rules. Your provider has all information available to safely exchange and dispose the defect batteries.

7 Transport

7.1 Transport — General Information



WARNING!

Risk of death or serious injury to the power wheelchair user and potentially any other nearby occupant of the vehicle, if a power wheelchair is secured using a tie-down system available from a third party supplier and the unladen weight of the power wheelchair exceeds the maximum weight for which the tie-down system is certified

- Make sure the weight of the power wheelchair does not exceed the weight for which the tie-down system is certified. Consult the tie-down manufacturer's documentation.
- If you are unsure how much your power wheelchair weighs, then you must have it weighed using calibrated scales.



WARNING!

Risk of Injury or Damage

If the power wheelchair is fitted with a tray or other auxiliary equipment this could break free during transfer to a vehicle and cause damage or injury to users in the event of a collision.

- When possible, other auxiliary power wheelchair equipment should be either secured to the power



wheelchair or removed from the power wheelchair and secured in the vehicle during travel.

- If a tray is fitted, always remove it before transporting the power wheelchair.



NOTICE!

- The vehicle should have the floor strength to take the combined weight of the occupant, the power wheelchair and accessories / options.

7.2 Transferring Power Wheelchair to Vehicle



WARNING!

Power wheelchair is at risk of tipping over if transferred to a vehicle while user is still seated in power wheelchair

- Transfer power wheelchair without user whenever possible.
- If power wheelchair with user must be transferred to vehicle using a ramp, ensure that ramp does not exceed rated slope.
- If power wheelchair must be transferred to vehicle using a ramp that does exceed rated slope, a winch must then be used. An attendant can then safely monitor and assist transfer process.



- Alternatively, a platform lift may be used.
- Ensure that total weight of power wheelchair including user does not exceed maximum permitted total weight for ramp or platform lift.
- Power wheelchair should always be transferred to vehicle with backrest in upright position, seat lifter lowered and tilt in upright position (refer to *5.7 Driving up and down Gradients, page 32*).



WARNING!

Risk of injury and damage to power wheelchair and vehicle

Risk of tipping over or uncontrolled movements of power wheelchair if transferred to vehicle using a ramp that exceeds rated slope.

- Transfer power wheelchair to vehicle without user.
- An attendant must assist transfer process.
- Ensure that all carer fully understand manual of ramp and winch.
- Ensure that winch is suitable for your power wheelchair.
- Use only suitable tie-down points. Do not use removable or movable components of power wheelchair as tie-down points.



WARNING!

Risk of injury and damage to power wheelchair

If power wheelchair must be transferred to vehicle via a lift, when remote is turned on, there is a risk that device may act erratically and fall off lift.

- Before transferring power wheelchair via lift, turn off product and disconnect either bus cable from remote or batteries from system.

1. Drive or push your power wheelchair into transport vehicle using suitable ramp.
2. Anchor the power wheelchair to the transport vehicle, refer to *7.3 Use Power Wheelchair as Vehicle Seat, page 41* and secure the user in the power wheelchair, refer to *7.3.2 Securing User in Power Wheelchair, page 44*.

7.3 Use Power Wheelchair as Vehicle Seat

Not every power wheelchair does automatically have the permission to be used as a vehicle seat. The following labels explain whether the power wheelchair can be used as a vehicle seat or not.

If the power wheelchair may NOT be used as a vehicle seat, this is identified by the following label:



If the power wheelchair can be used as a vehicle seat, the tie-down points are identified by the following label:



In order to use a power wheelchair as a vehicle seat, it must be fitted with tie-down points to enable anchoring in the motor vehicle. These accessories / options may be included in the standard scope of power wheelchair order and delivery in some countries (UK for example), but may also be obtained from Invacare as an option in other countries.

The following information is only relevant if your power wheelchair can be used as a vehicle seat:



WARNING!

Risk of Serious Injury

The power wheelchair has been designed and tested to conform to the requirements of ISO 7176-19 for use only as forward-facing seat in a motor vehicle.

The power wheelchair has been dynamically tested in a forward-facing orientation with the ATD (anthropomorphic test device, "crash-test dummy") restrained by a three-point belt restraint.

If any of the instructions is not followed, serious injuries or damage can occur in an event of a collision:



- Alterations or substitutions shall not be made to the power wheelchair securement points or to structural and frame parts or components since this can affect the crashworthiness of the power wheelchair, and it can also change the performance of the power wheelchair in normal use. If it is considered necessary to make these kinds of alterations, Invacare shall be consulted.
- Only use spill-proof sealed batteries approved by Invacare.
- It is imperative that the power wheelchair is inspected by an authorised provider for determination whether the power wheelchair is suitable for reuse after any type of vehicle collision.

The power wheelchair may be used as a vehicle seat in connection with an anchoring system that has been checked and approved in accordance with ISO 10542. The transporting vehicle must be professionally converted to anchor the power wheelchair. Contact your vehicle's manufacturer for more information.



If possible, the user should always leave the power wheelchair to use a vehicle seat and the vehicle-manufacturer installed restraint system. The unoccupied power wheelchair should be stored in a cargo area or secured in the vehicle during travel.

A power wheelchair permitted as vehicle seat has undergone a crash test in accordance to ISO 7176–19 for use in road vehicles and meets the requirements for forward facing transport and head on collisions. The "crash-test dummy" was secured using pelvic and upper body safety belts. Both types of safety belt should be used in order to minimize the risk of injuries to head or upper body.

 Invacare tests with tie-down systems, that meet the requirements of ISO 10542-1 and the curb weight of the power wheelchair. For information concerning the curb weight, refer to *10.1 Technical Specifications, page 58.*

7.3.1 How the Power Wheelchair is Anchored in a Vehicle

The power wheelchair is fitted with tie-down points. Snap hooks or belt loops can be used for fixation.



CAUTION!

There is a risk of injury if the power wheelchair is not properly secured during use as a vehicle seat

- Always use a tie-down system suitable for the combined weight of occupant and power wheelchair.
- If possible, the user should always leave the power wheelchair to use a vehicle seat and the safety belts provided with the vehicle.
- The power wheelchair should always be anchored facing in the transport vehicle's intended direction of travel.
- The power wheelchair must always be secured in accordance with the power wheelchair and anchoring system manufacturers' operating manual.
- Always remove and secure any accessory parts fixed to the power wheelchair such as chin controls or tables.
- If your power wheelchair is equipped with an angle adjustable backrest, then it must be placed in an upright position.
- Fully lower elevated legrests, if fitted.
- Fully lower the seat lifter, if fitted.

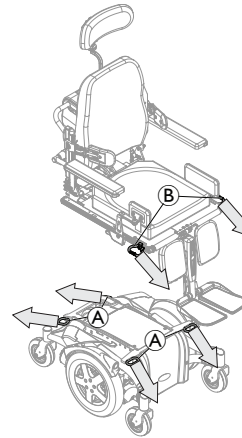

The arrows indicate the direction of fixation to the vehicle.

1. Secure the forward-facing power wheelchair with the tie-down system belts at the following locations:
 - a. Four tie-down points **A** on power wheelchair base (two at front and two at rear).
 - b. Only Ultra Low Maxx seating systems with lifter: Two additional tie down points **B** on each side of the seat.
2. Secure the power wheelchair by tensioning the belts in accordance with the tie-down system manufacturer's user manual.

7.3.2 Securing User in Power Wheelchair



CAUTION!

Risk of injury during use of the power wheelchair as a vehicle seat if a headrest is wrongly adjusted or not installed

This can cause the neck to be hyperextended during collisions.

- A headrest must be installed. The headrest optionally supplied for this power wheelchair by Invacare is perfectly suitable for use during transport.
- The headrest must be adjusted to the user's ear height.

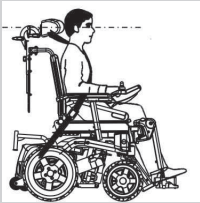

The "crash test dummy" was secured using pelvic and upper body safety belts. Both types of safety belt should be used in order to minimize the risk of injuries to head or upper body.



CAUTION!

Risk of injury if the user is not properly secured within the power wheelchair

- Safety restraint devices must only be used when the wheelchair user's weight is 23 kg or more.
- Even if the power wheelchair is fitted with a posture belt or any other power wheelchair integrated belt system, this is no substitute for a proper safety belt which complies with ISO 10542 in the transport vehicle. Always use the safety belt installed in the transport vehicle.
- Safety belts must be pulled as tightly as possible without causing the user discomfort.
- Safety belts must not be positioned while twisted.
- Ensure that the third seat belt anchorage point is not fixed directly to the vehicle floor, but to one of the vehicle uprights.
- Both pelvic and upper torso restraint belts must be used to restrain the occupant to reduce the possibility of head and chest impacts with the vehicle components. They shall be used together only as designed for.
- Any wheelchair anchored occupant restraint i.e. 3-point belt, harness or postural supports (lap straps, lap belts) should not be used or relied on for occupant restraint in a moving vehicle. Always use a vehicle anchored and certified occupant restraint system instead.



- Care should be taken when applying the occupant restraint to position the seatbelt buckle so that the release button will not be contacted by power wheelchair components during transport and during a crash
- Safety belts must be in contact with the user's body. They must not be held at a distance from the user's body using parts of the power wheelchair such as armrests or wheels.

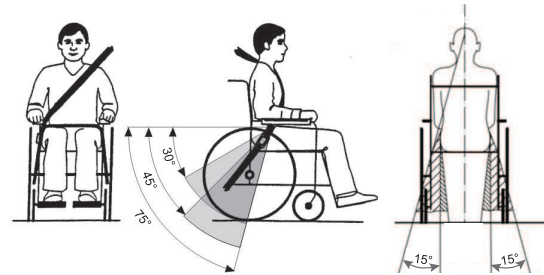

The pelvic belt should be positioned in the area between the user's pelvis and thighs so that it is unobstructed and not too loose. The ideal angle of the pelvic belt to the horizontal is between 45° and 75°. The maximum permissible angle is between 30° and 75°. The angle should never be less than 30°!

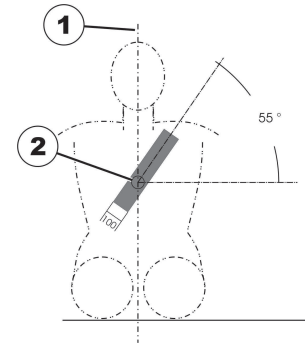

The safety belt installed in the transporting vehicle should be applied as shown in the illustration above.

1) centre line of the body

2) centre of the sternum

7.4 Transporting Power Wheelchair Without Occupant



CAUTION! Risk of injury

- If you are unable to fasten your power wheelchair securely in a transport vehicle, Invacare recommends that you do not transport it.

Your power wheelchair may be transported without restrictions, whether by road, rail or by air. Individual transport companies have, however, guidelines which can possibly restrict or forbid certain transport procedures. Please ask the transport company regarding each individual case.

- Before transporting your power wheelchair, make sure the motors are engaged and that the remote is switched off.
- Invacare strongly recommends that you additionally disconnect or remove the batteries. Refer to the corresponding chapter about disconnecting the batteries in the service manual, which is available through Invacare.
- Invacare strongly recommends securing the power wheelchair to the floor of the transporting vehicle.

7.5 Dahl Docking System

If a power wheelchair is equipped with a Dahl Docking System adapter plate, the following label appears on the backrest of the power wheelchair. The value on the label explains the ground clearance of the power wheelchair, fitted with a Dahl Docking system adapter plate.

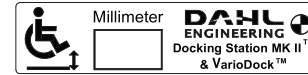

WARNING! Risk of Death, Serious Injury or Damage

If the power wheelchair is not secured in a forward facing direction in the Dahl Docking station, death, serious injury or damage may occur.

- The wheelchair should be secured in a forward facing direction. This wheelchair is tested to ISO 7176-19, for use in road vehicles and meets the requirements for forward facing transport and head on collisions. The wheelchair has not been tested for other directions in a vehicle.

Installation of Dahl Docking Stations in Vehicles

Only professional companies in the business of converting or building wheelchair accessible vehicles can order the docking system from Dahl Engineering. A qualified and experienced technician must carry out the installation. Dahl Engineering can provide vehicle specific installation instructions for a large range of vehicles, which must be respected by the fitter. Please contact Dahl Engineering for further information about approved vehicles and fitting positions. Dahl Engineering contact details are available at: www.dahlengineering.dk.



To retrofit a power wheelchair with a Dahl Docking system, it is imperative, that the power wheelchair is equipped with the correct adapter plate. This adapter plate must be threaded to fix the lock plate of the Dahl Docking system underneath the power wheelchair. For more information about retrofitting, contact your provider.

i The maximum payload with the Dahl Docking system is 136 kg. The maximum weight of the power wheelchair must not exceed 200 kg.

i The description of how to install the Dahl Docking system to maintain the CE-marking of the product is contained in the service manual of this power wheelchair, which is available through Invacare.

i For more information about spare parts, accessory / option part installation in vehicles and maintenance of the Dahl Docking system, contact Dahl Engineering.

i **Positioning the occupant restraint when using it with the Dahl Docking system only**

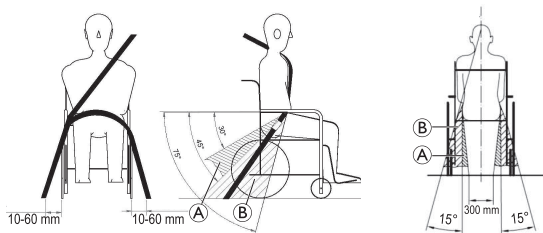

When using power wheelchair with a Dahl Docking system, the floor anchorage points for the occupant restraint system should be located 10 – 60 mm outside wheels on each side. The pelvic belt must be worn low across the front of the pelvis so that the angle of the pelvic belt is within the preferred zone **A** of 30° to 45° as shown. A steeper angle within the optional zone **B**, 45° to 75° is desirable, but never exceeding 75°.

Components of Dahl Docking System

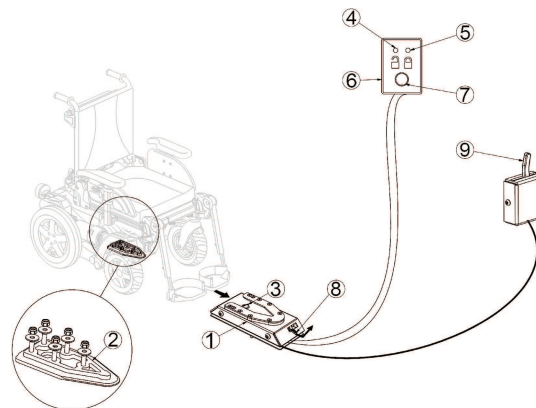

- (1) Dahl Docking station
- (2) Lock plate and 8 mm spacer
- (3) Locking pin
- (4) Red LED
- (5) Green LED
- (6) Control panel
- (7) Release button
- (8) Manual emergency release lever
- (9) Manual operating lever (optional)

Dahl Engineering offers two Dockings systems, the MK II (Dahl No. 501750), and a power height adjustable called Dahl VarioDock (Dahl No. 503600).

Locking in Dahl Docking Station



WARNING!

Risk of Death, Serious Injury or Damage

If the vehicle is moved while the power wheelchair is not correctly secured in the Dahl Docking station, death, serious injury or damage may occur.

- Do not move the vehicle while the power wheelchair is maneuvered into position in the Dahl Docking station.
- Do not move the vehicle if power wheelchair and user are not correctly secured.
- Do not move the vehicle if the warning tone sounds and / or if the red LED in the control panel flashes or is lit.

1. Maneuver power wheelchair slowly and in straight direction over Dahl Docking station (1).

Fig. 7-1 View from back

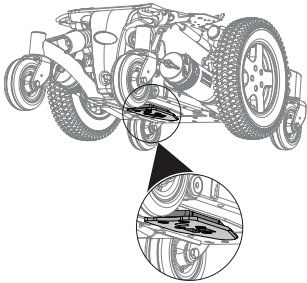

Lock plate (2) underneath power wheelchair helps to guide power wheelchair into Dahl Docking station.

2. If lock plate is fully engaged in Dahl Docking station, locking pin (3) automatically secures lock plate.
3. Dahl Docking station is equipped with control switch that indicates if lock plate is correctly secured in Dahl Docking station.

As soon as lock plate comes in contact with locking pin, warning tone sounds (high-pitched howl) and red LED in control panel (6) lights up until lock plate is either fully engaged or power wheelchair is removed from Dahl Docking station.

4. When power wheelchair is properly secured, warning tone ceases, red LED goes out and green LED lights up.
5. Buckle up with seat belt of vehicle.



Always check before moving the vehicle if lock plate is properly engaged in the Dahl Docking station by trying to reverse the power wheelchair out of the Dahl Docking station. It must not be possible to reverse out of the Dahl Docking station without pressing the red release button (7) in the control panel.

Unlocking from Dahl Docking Station

1. Stop and prevent vehicle from moving.
2. Remove seat belt.
3. Move power wheelchair forward to release pressure on locking pin.
4. Press red release button (7) in control panel.

Locking pin is released for approx. five seconds, after which locking pin is automatically locked again.

5. Move power wheelchair away from Dahl Docking station within five-second period.

Do not attempt to reverse power wheelchair until red LED, which indicates unlock position, lights up.

-  Attempting to reverse the power wheelchair before the red LED lights up, results in blocking the Dahl Docking station's locking mechanism, which makes it impossible to reverse. If this happens, repeat unlocking procedure.

Manual Unlocking in Case of Electrical Failure

-  The following instructions require the help of an attendant.

1. Move power wheelchair forward to release pressure on locking pin.
2. Push manual emergency release lever (8) to one side and hold it there, while power wheelchair moves away.
3. A cable-activated manual operating lever (9) can also be fitted (accessory / option).

Push lever to one side and hold it there, while power wheelchair moves away.

-  If the manual unlocking procedure fails, an emergency release tool made from red plastic comes with each Dahl Docking station.

1. Move power wheelchair forward to release pressure on locking pin.

2.



Place emergency release tool in gap between locking plate and Dahl Docking station.

3.



Push emergency release tool and power wheelchair forward until locking pin has been forced down.

4. Move power wheelchair away from Dahl Docking station.

8 Maintenance

8.1 Maintenance Introduction

The term “Maintenance” means any task performed to ensure that a medical device is in good working order and ready for use as intended. Maintenance encompasses different areas, such as everyday care and cleaning, inspection checks, repair tasks and refurbishment.



It is recommended, to have your power wheelchair checked once a year by an authorised Invacare provider to maintain its driving safety and roadworthiness.

8.2 Inspection Checks

The following tables list inspection checks that should be performed by the user and their intervals. If the power wheelchair fails to pass one of the inspection checks, refer to the chapter indicated or contact your authorised Invacare provider. A more comprehensive list of inspection checks and instructions for maintenance work can be found in the service manual for this device, which is available through Invacare. That manual, however, is intended to be used by trained and authorised service technicians, and describes tasks which are not intended to be performed by the user.

8.2.1 Before Each Use of Power Wheelchair

Item	Inspection Check	If Not Passed
Screwed connections	Check all connections, such as backrests and wheels, for tight fit.	Contact your provider.
Signal horn	Check for correct function.	Contact your provider.
Lighting system	Check that all lights, such as turn indicators, head lamps and tail lights, are functioning correctly.	Contact your provider.
Battery box locking system	Check to ensure that the battery box locking system is functioning correctly. Locking pins must be completely engaged in the holes provided for them (refer to <i>7.4 Transporting Power Wheelchair Without Occupant</i> , page 46).	Contact your provider.
Batteries	Make sure the batteries are charged. See the user manual provided with your remote for a description of the battery charge indicator.	Charge the batteries (refer to <i>6.2.3 Charging Batteries</i> , page 36).

8.2.2 Weekly

Item	Inspection Check	If Not passed
Armrests / side parts	Check that armrests are firmly attached in their holders and do not wobble.	Tighten the screw or clamping lever that holds the armrest. Contact your provider.
Tires (pneumatic)	Check that the tires are undamaged.	Contact your provider.
	Check that the tires are inflated to the correct pressure.	Inflate the tire to the correct pressure (refer to <i>8.3 Wheels and Tyres</i> , page 53 and <i>10.1 Technical Specifications</i> , page 58).
Tires (puncture-proof)	Check that the tires are undamaged.	Contact your provider.
Antitippers	Check that antitippers are firmly attached and do not wobble.	Contact your provider.

Item	Inspection Check	If Not passed
	Check that the spring clips of the antitippers are in good order and secure the antitippers correctly.	

8.2.3 Monthly

Item	Inspection Check	If Not Passed
All upholstered parts	Check for damage and wear.	Contact your provider.
Removable legrests	Check whether legrests can be fixed securely and whether loosening mechanism is properly operable.	Contact your provider.
	Check that all adjustment options function properly.	Contact your provider.
Castors	Check that castors rotate and swivel freely.	Contact your provider.
Drive wheels	Check that drive wheels rotate without wobbling. It is easiest to have someone stand behind power wheelchair and observe drive wheels as you drive away from them to do this.	Contact your provider.
Electronics and connectors	Check all cables for damage and all connecting plugs for snug fit.	Contact your provider.

8.3 Wheels and Tyres

Dealing With Wheel Damages

In case of having a damaged wheel, contact your provider. Because of safety reasons do not have the wheel repaired by yourself or by not authorised persons.

Dealing With Pneumatic Tyres

! NOTICE! Risk of damage to tyre and rim

Never drive with too low tyre pressure, this could result in damage to tyre.

If tyre pressure is exceeded rim could be damaged.

- Inflate tyres to recommended pressure.



Use tyre gauge to check pressure.

Check weekly that the tyres are inflated to the correct pressure, refer to *8.2.1 Before Each Use of Power Wheelchair, page 51*.

For recommended tyre pressure see inscription on tyre / rim or contact Invacare. Compare table below for conversion.

psi	bar
22	1.5
23	1.6
25	1.7
26	1.8

psi	bar
28	1.9
29	2.0
30	2.1
32	2.2
33	2.3
35	2.4
36	2.5
38	2.6
39	2.7
41	2.8
44	3.0

8.4 Short-Term Storage

In case a serious fault is detected, a number of safety mechanisms are built into your power wheelchair and will protect it. The power module prevents your power wheelchair from driving.

When the power wheelchair is in such a condition and while waiting for repair:

1. Switch off power.
2. Disconnect the batteries.

Depending on the power wheelchair model, you can either remove the battery packs or disconnect the batteries from the power module. Refer to the corresponding chapter about disconnecting the batteries in the service manual, which is available through Invacare.

3. Contact your provider.

8.5 Long-Term Storage

In case your power wheelchair is not used for a longer period of time, you need to prepare it for storage to ensure a longer life for your power wheelchair and batteries.

Storing Power Wheelchair and Batteries

- We recommend to store the power wheelchair at a temperature of 15 °C, avoid hot and cold extremes when storing to ensure a long service life of the product and batteries.
- The components are tested and approved for greater temperature ranges as detailed below:
 - Allowable temperature range to store the power wheelchair is -40° up to 65 °C.
 - Allowable temperature range to store batteries is -25° up to 65 °C.
- Even not being used, batteries discharge themselves. Best practice is to disconnect the battery supply from the power module if storing the power wheelchair longer than two weeks. Depending on the power wheelchair model, you can either remove the battery packs or disconnect the batteries from the power module. Refer to the corresponding chapter about disconnecting the batteries in the service manual, which is

available through Invacare. If in doubt which cable to disconnect, contact your provider.

- Batteries should always be fully charged before storing.
- If storing the power wheelchair longer than four weeks, check the batteries once a month and recharge as needed (before gauge reads half full) to avoid damage.
- Store in a dry, well-ventilated environment protected from outer influences.
- Slightly overinflate pneumatic tyres.
- Position the power wheelchair on flooring that is not discoloured by contact with tyre rubber.

Preparing Power Wheelchair for Use

- Re-connect the battery supply to the power module.
- The batteries must be charged before use.
- Have the power wheelchair checked by an authorised Invacare provider.

8.6 Cleaning and Disinfection

8.6.1 General Safety Information



CAUTION! Risk of Contamination

- Take precautions for yourself and use appropriate protective equipment.

**CAUTION!****Risk of Electric Shock and Product Damage**

- Switch off the device and disconnect from mains, if applicable.
- When cleaning electronic components consider their protection class regarding water ingress.
- Make sure that no water splashes to the plug or the wall outlet.
- Do not touch the power socket with wet hands.

**NOTICE!**

- Wrong fluids or methods can harm or damage the product.
- All cleaning agents and disinfectants used must be effective, compatible with one another and must protect the materials they are used to clean.
 - Never use corrosive fluids (alkalines, acid etc.) or abrasive cleaning agents. We recommend an ordinary household cleaning agent such as dishwashing liquid, if not specified otherwise in the cleaning instructions.
 - Never use a solvent (cellulose thinner, acetone etc.) that changes the structure of the plastic or dissolves the attached labels.
 - Always make sure that the product is completely dried before taking into use again.



For cleaning and disinfection in clinical or long-term care environments, follow your in-house procedures.

8.6.2 Cleaning Intervals**NOTICE!**

Regular cleaning and disinfection enhance smooth operation, increases the service life and prevents contamination.

Clean and disinfect the product:

- regularly while in use,
- before and after any service procedure,
- when it has been in contact with any body fluids,
- before using it for a new user.

8.6.3 Cleaning**NOTICE!**

- The product does not tolerate cleaning in automatic washing plants, with high-pressure cleaning equipment or steam.

**NOTICE!**

Dirt, sand and seawater can damage the bearings and steel parts can rust if the surface is damaged.

- Only expose the wheelchair to sand and seawater for short periods and clean it after every trip to the beach.
- If the wheelchair is dirty, wipe off the dirt as soon as possible with a damp cloth and dry it carefully.

1. Remove any installed optional equipment (only optional equipment which does not require tools).

2. Wipe down the individual parts using a cloth or soft brush, ordinary household cleaning agents (pH = 6 - 8) and warm water.
3. Rinse the parts with warm water.
4. Thoroughly dry the parts with a dry cloth.



Car polish and soft wax can be used on painted metal surfaces to remove abrasions and restore gloss.

Cleaning Upholstery

For cleaning upholstery refer to the instructions on the labels of the seat, cushion and backrest cover.



If possible, always overlap hook and loop strips (the self-gripping parts) when washing, to minimize lint and thread build-up on hook strips and prevent damage to upholstery fabric by these.

8.6.4 Disinfection Instructions

Method: Follow the application notes for the used disinfectant and wipe-disinfect all accessible surfaces.

Disinfectant: Ordinary household disinfectant.

Drying: Allow the product to air-dry.

9 After Use

9.1 Reconditioning

This product is suitable for reuse. To recondition the product for a new user, carry out the following actions:

- Inspection according to service plan, refer to the service manual, which is available through Invacare.
- Cleaning and disinfection, refer to *8.6 Cleaning and Disinfection, page 54*.
- Adaptation to the new user, refer to *1 Setup, page 1* or the Setup chapter in the seating manual, if available.

Make sure that the user manual is handed over with the product.

If any damage or malfunction is detected, do not reuse the product.

9.2 Disposal



WARNING!

Environmental Hazard

Device contains batteries.

This product may contain substances that could be harmful to the environment if disposed of in places (landfills) that are not appropriate according to legislation.

- DO NOT dispose of batteries in normal household waste.
- DO NOT throw batteries into a fire.
- Batteries **MUST** be taken to a proper disposal site. The return is required by law and free of charge.
- Only dispose of discharged batteries.
- Cover terminals of batteries prior to disposal.
- For information about the correct handling of damaged batteries, refer to *6.2.9 Handling Damaged Batteries Correctly, page 39*.

Be environmentally responsible and recycle this product through your recycling facility at its end of life.

Disassemble the product and its components, so the different materials can be separated and recycled individually.

The disposal and recycling of used products and packaging must comply with the laws and regulations for waste handling in each country. Contact your local waste management company for information.

10 Technical Data

10.1 Technical Specifications

The technical information provided hereafter applies to a standard configuration or represents maximum achievable values. These can change if accessories / options are added. The precise changes to these values are detailed in the sections for the respective accessories / options.

Note that there may be values in this list, which are not relevant to your product, since this list applies to all available models (on the date of printing). If not otherwise stated, each value in this list refers to all models of the product.

The models and configurations available in your country can be found in the country-specific sales documents.



Note that in some cases the measured values may vary up to ± 10 mm.

Permissible Operating and Storage Conditions	
Temperature Range for Operation According to ISO 7176-9	<ul style="list-style-type: none"> -25 °C – +50 °C
Recommended Storage Temperature	<ul style="list-style-type: none"> +15 °C
Temperature Range for Storage According to ISO 7176-9	<ul style="list-style-type: none"> -25 °C – +65 °C with batteries -40 °C – +65 °C without batteries

Electrical System	
Batteries	<ul style="list-style-type: none"> 2 x 12 V/73.5 Ah (C20) / 63 Ah (C5) sealed VRLA gel (TDX SP2) 2 x 12 V/60 Ah (C20) / 47.4 Ah (C5) sealed VRLA gel (TDX SP2) 2 x 12 V/50 Ah (C20) / 43.2 Ah (C5) sealed VRLA gel (TDX SP2 NB)
Main Fuse	<ul style="list-style-type: none"> 80 A (TDX SP2) 125 A (TDX SP2 NB)
Degree of Protection	<ul style="list-style-type: none"> IPX4¹

Charging Device	
Output Current	<ul style="list-style-type: none"> • 8 A • 10 A
Output Voltage	<ul style="list-style-type: none"> • 24 V nominal

Drive Wheel Tyres	
Tyre Type	<ul style="list-style-type: none"> • 3.00 - 8" puncture-protected, puncture-proof, pneumatic
Tyre Pressure	The recommended maximum tyre pressure in bar or kpa is marked on the side wall of the tyre or the rim. If more than one value is listed, the lower one in the corresponding units applies. (Tolerance = -0.3 bar, 1 bar = 100 kpa)

Castor Tyres	
Tyre Type	<ul style="list-style-type: none"> • 6 x 2" solid
Tyre Pressure	The recommended maximum tyre pressure in bar or kpa is marked on the side wall of the tyre or the rim. If more than one value is listed, the lower one in the corresponding units applies. (Tolerance = -0.3 bar, 1 bar = 100 kpa)

Driving Characteristics	
Speed	<ul style="list-style-type: none"> • 3 km/h • 6 km/h • 10 km/h • 12 km/h
Max. Stopping Distance	<ul style="list-style-type: none"> • 400 mm (3 km/h) • 1000 mm (6 km/h) • 2100 mm (10 km/h) • 2900 mm (12 km/h)
Rated Slope ² :	<ul style="list-style-type: none"> • 9° (15.8 %) according to manufacturer's specifications with 160 kg payload, 4° seat angle, 20° backrest angle
Max. Climbable Obstacle Height	<ul style="list-style-type: none"> • Forward 75 mm • Reverse 50 mm
Turning Diameter	<ul style="list-style-type: none"> • min. 1280 mm
Pivot Width	<ul style="list-style-type: none"> • min. 1140 mm
Drive range in accordance with ISO 7176-4 ³ :	
50 Ah batteries	<ul style="list-style-type: none"> • up to 28 km
60 Ah batteries	<ul style="list-style-type: none"> • up to 30 km
73.5 Ah batteries	<ul style="list-style-type: none"> • up to 41 km

Dimensions According to ISO 7176-5	Seat Type		
	Ultra Low Maxx	Modulite	Max
Base Width	<ul style="list-style-type: none"> • 615 mm (TDX SP2 NB) • 650 mm (TDX SP2) 		
Stowage Length	<ul style="list-style-type: none"> • 900 – 1010 mm 		
Stowage Width	<ul style="list-style-type: none"> • 630 – 835 mm 		
Stowage Height	<ul style="list-style-type: none"> • 710 – 1143 mm 		
Ground Clearance	<ul style="list-style-type: none"> • > 65 mm 		
Overall Height (Without Seat Angle Adjustment or Lifter)	<ul style="list-style-type: none"> • – 	<ul style="list-style-type: none"> • 1010 mm (one piece seat plate) • 1010 - 1140 mm (telescopic seat frame, moving the backrest plate) 	<ul style="list-style-type: none"> • 1100 mm • 1125 mm
Overall Height (With Seat Angle Adjustment or Lifter)	<ul style="list-style-type: none"> • 1080 – 1210 mm (without headrest) • 1080 – 1535 mm (with headrest) 	<ul style="list-style-type: none"> • 1170 mm (telescopic seat frame, moving the backrest plate) 	<ul style="list-style-type: none"> • 1100 mm • 1125 mm
Total Length (incl. Standard Legrests)	<ul style="list-style-type: none"> • 1290 mm 	<ul style="list-style-type: none"> • 1160 mm 	<ul style="list-style-type: none"> • 1240 mm
Total Length (Without Standard Legrests)	<ul style="list-style-type: none"> • 980 mm 	<ul style="list-style-type: none"> • 980 mm 	<ul style="list-style-type: none"> • 970 mm

Dimensions According to ISO 7176-5	Seat Type	
	Modulite	Max
Max. Total Width	<ul style="list-style-type: none"> • 615 mm (chassis TDX SP2 NB)⁴ • 650 mm (chassis TDX SP2) • 675 mm (seat width 48) • 725 mm (seat width 53) 	<ul style="list-style-type: none"> • 855 mm (seat width 49) • 915 mm (seat width 55) • 975 mm (seat width 61)
Seat-to-Floor Height ⁵ (Without Seat Angle Adjustment or Lifter)	<ul style="list-style-type: none"> • 450 mm • 475 mm 	<ul style="list-style-type: none"> • 470 mm • 495 mm
Seat-to-Floor Height ⁵ (With Seat Angle Adjustment)	<ul style="list-style-type: none"> • 450 mm (manual and 20° electrical adjustment) • 475 mm (20° electrical adjustment) 	<ul style="list-style-type: none"> • 470 mm • 495 mm
Seat-to-Floor Height ⁵ (With Lifter or 30° Seat Angle Adjustment)	<ul style="list-style-type: none"> • 475 – 775 mm • 420 – 720 mm (TDX SP2 Low-Rider with 73.5 Ah batteries) • 403 – 703 mm (TDX SP2 Low-Rider with 60 Ah batteries) 	<ul style="list-style-type: none"> • –

Dimensions According to ISO 7176-5	Seat Type	
	Ultra Low Maxx	
Max. Total Width	<ul style="list-style-type: none"> • 630 mm (seat width 405) • 650 mm (chassis TDX SP2) • 655 mm (seat width 430) • 680 mm (seat width 455) • 705 mm (seat width 480) 	<ul style="list-style-type: none"> • 735 mm (seat width 505) • 760 mm (seat width 530) • 785 mm (seat width 555) • 810 mm (seat width 580) • 835 mm (seat width 610)
Seat-to-Floor Height ⁵ :		
with Tilt Module only and / or 5° Anterior-tilt and / or 10° Anterior-tilt	<ul style="list-style-type: none"> • 420 mm (only in combination with 8.5° anterior tilt) • 440 mm • 460 mm • 480 mm 	
with Lifter / Tilt Module only and / or 5° Anterior-tilt and / or 10° Anterior-tilt	<ul style="list-style-type: none"> • 444 mm – 744 mm • 464 mm – 764 mm • 484 mm – 784 mm 	
with Tilt module and 5° Pre-tilt	<ul style="list-style-type: none"> • 500 mm • 520 mm • 540 mm 	
with Lifter / Tilt Module and 5° Pre-tilt	<ul style="list-style-type: none"> • 504 mm – 804 mm • 524 mm – 824 mm • 544 mm – 844 mm 	

Footrests and Legrests		
Vari F	Length	<ul style="list-style-type: none"> • 290 - 460 mm
	Angle	<ul style="list-style-type: none"> • 70° - 0°

Footrests and Legrests		
Vari A	Length	<ul style="list-style-type: none"> • 290 - 460 mm
	Angle	<ul style="list-style-type: none"> • 70° – 0°
ADE (electric)	Length	<ul style="list-style-type: none"> • 290 - 460 mm
	Angle	<ul style="list-style-type: none"> • 80° – 0°
ADM (manual)	Length	<ul style="list-style-type: none"> • 290 - 460 mm
	Angle	<ul style="list-style-type: none"> • 80° – 0°
Centre-Mounted (manual)	Length	<ul style="list-style-type: none"> • 280 – 385 mm
	Angle	<ul style="list-style-type: none"> • 90° – 0°
Centre-Mounted Powered LNX	Length	<ul style="list-style-type: none"> • 340 – 410 mm
	Angle	<ul style="list-style-type: none"> • 97° – 7° • 90° – 0° • 83° – -7°

Weight ⁷	TDX SP2 NB	TDX SP2
Kerb Weight With Fixed Seat Angle	<ul style="list-style-type: none"> • approx. 138 kg 	<ul style="list-style-type: none"> • approx. 154 kg
Kerb Weight With 20° Electrical Seat Angle Adjustment	<ul style="list-style-type: none"> • approx. 145 kg 	<ul style="list-style-type: none"> • approx. 164 kg
Kerb Weight With 30° Electrical Seat Angle Adjustment	<ul style="list-style-type: none"> • approx. 151 kg 	<ul style="list-style-type: none"> • approx. 170 kg
Kerb Weight With Lifter	<ul style="list-style-type: none"> • approx. 164 kg 	<ul style="list-style-type: none"> • approx. 183 kg

Component Weights	
73.5 Ah Batteries	<ul style="list-style-type: none"> • approx. 23 kg per battery

Component Weights	
60 Ah Batteries	<ul style="list-style-type: none"> approx. 20 kg per battery
50 Ah Batteries	<ul style="list-style-type: none"> approx. 17 kg per battery
Payload	
Max. Payload	<ul style="list-style-type: none"> 136 kg (TDX SP2 Sprint) 136 kg (TDX SP2 with Ultra Low Maxx seating system) 150 kg (TDX SP2 NB) 160 kg (6 km/h with lifter or 30° seat angle adjustment) 180 kg (6 km/h with 20° or fixed seat angle adjustment)
Axle Loads	
Max. Front Axle Load	<ul style="list-style-type: none"> 106 kg
Max. Rear Axle Load	<ul style="list-style-type: none"> 97 kg
Max. Centre Axle Load	<ul style="list-style-type: none"> 217 kg

- 1 IPX4 classification means that the electrical system is protected against spray water.
- 2 Static stability downhill, uphill, and sideways according to ISO 7176-1 = 9° (15.8 %)
Dynamic stability uphill according to ISO 7176-2 = 6° (10.5 %)
- 3 Note: The drive range of a power wheelchair is strongly influenced by external factors, such as the speed setting of the wheelchair, the charging state of the batteries, surrounding temperature, local topography, road surface characteristics, tyre pressure, weight of user, drive style and use of batteries for lighting, servos etc.
The specified values are theoretical maximum achievable values measured according to ISO 7176-4.
- 4 Measured with solid tyres. Pneumatic tyres can increase the max. total width.
- 5 Measured without seat cushion
- 6 Distance between backrest reference plane and most forward part of armrest assembly
- 7 The actual kerb weight depends on the fittings your power wheelchair has been supplied with. Every Invacare power wheelchair is weighed when leaving the works. Refer to the nameplate for the kerb weight (including batteries) measured.

11 Service

11.1 Inspections Performed

It is confirmed by stamp and signature that all jobs listed in the inspection schedule of the service and repair instructions have been properly performed. The list of the inspection jobs to be performed can be found in the service manual which is available through Invacare.

Delivery Inspection	1st Annual Inspection
Stamp of authorised provider / Date / Signature	Stamp of authorised provider / Date / Signature
2nd Annual Inspection	3rd Annual Inspection
Stamp of authorised provider / Date / Signature	Stamp of authorised provider / Date / Signature

4th Annual Inspection	5th Annual Inspection
Stamp of authorised provider / Date / Signature	Stamp of authorised provider / Date / Signature

**Australia:**

Invacare Australia Pty. Ltd.
Unit 18/12 Stanton Road,
Seven Hills, NSW 2147,
Australia
Phone: 1800 460 460
Fax: 1800 814 367
orders@invacare.com.au
www.invacare.com.au

EU Export:

Invacare Poirier SAS
Route de St Roch
F-37230 Fondettes
Phone: (33) (0) 2 47 62 69 80
serviceclient_export@invacare.com
www.invacare.eu.com

Canada

Invacare Canada LP
c/o Motion Concepts Canada
84 Citation Drive Unit 11
Concord, Ontario L4K 3C1

New Zealand:

Invacare New Zealand Ltd
4 Westfield Place, Mt Wellington
1060
New Zealand
Phone: 0800 468 222
Fax: 0800 807 788
sales@invacare.co.nz
www.invacare.co.nz

United Kingdom & Ireland:

Invacare Limited
Pencoed Technology Park, Pencoed
Bridgend CF35 5AQ
Phone: (44) (0) 1656 776 200
uk@invacare.com
www.invacare.co.uk



Invacare GmbH
Am Achener Hof 8
D-88316 Isny
Germany



Invacare UK Operations Limited
Unit 4, Pencoed Technology Park, Pencoed
Bridgend CF35 5AQ
UK

1578997-0 2024-09-10



Making Life's Experiences Possible®



Yes, you can.®